



IEEE 2018 Seminar

追求國際化與新潮化的學術研究經驗談

Personal Experiences in Global and Modern Research Promotion

楊家輝

Jar-Ferr Kevin Yang

*2018.5.24



簡報大綱

IEEE 2018
Seminar

1

介紹 - 研究歷程

2

國際學會參與 (Passive)

3

參與國際學會 (Active)

4

建立國際化推動團隊 (Proactive)

5

結論



介紹 - 研究歷程

IEEE 2018
Seminar

研究方向與改變：

- Stereo 3D Technology
- Pattern Recognition and Deep Learning
- Multimedia in DSP Chip Implementation
- Multimedia Signal Processing and Compression
- Neural Network and Adaptive Filters (1988-1994)
- Spectrum Estimation (1984-1988)
- Array Signal Processing (1984-1988)

Ph.D.
Research

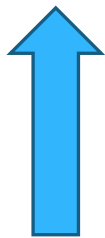
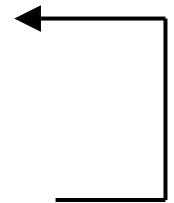



博士研究過程

(1984 -1988)

IEEE 2018
Seminar

Research Topics :

- Spectrum Estimation (1984-1988)
- Array Signal Processing (1984-1988)
- Courses Taken:

Built Math/Statistics
Background and
Using PC-MATLAB
Software Package

- Statistics I, II, III, Multivariate Analyses, Time Series Analyses
 - Linear Algebra, Linear System
 - Random Process, Detection Theory, Estimation
- Introducing MATLAB Programming in UM



陣列訊號處理

(Array Signal Processing)

IEEE 2018
Seminar

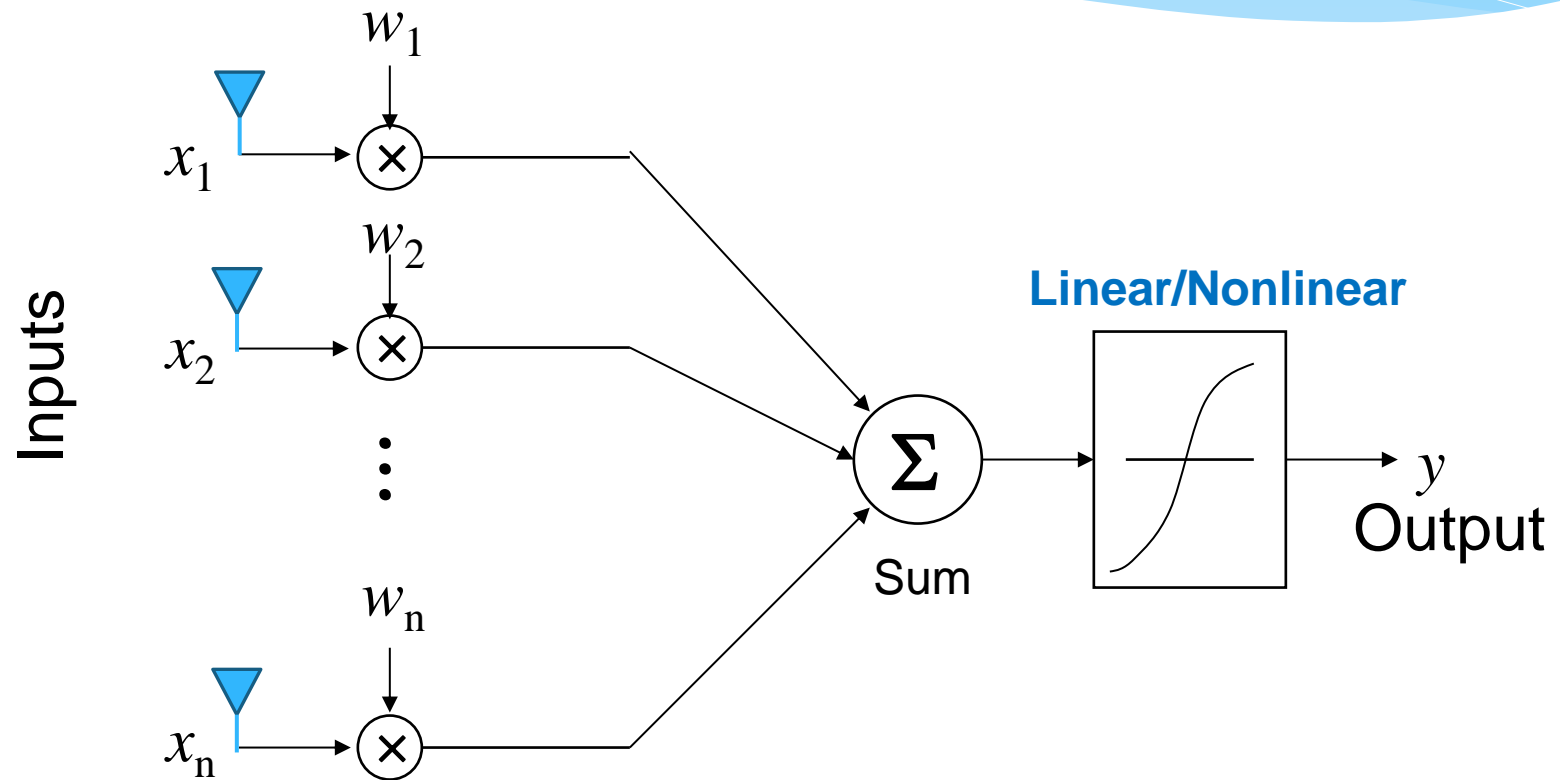



系統最佳化

(System Optimization)

IEEE 2018
Seminar

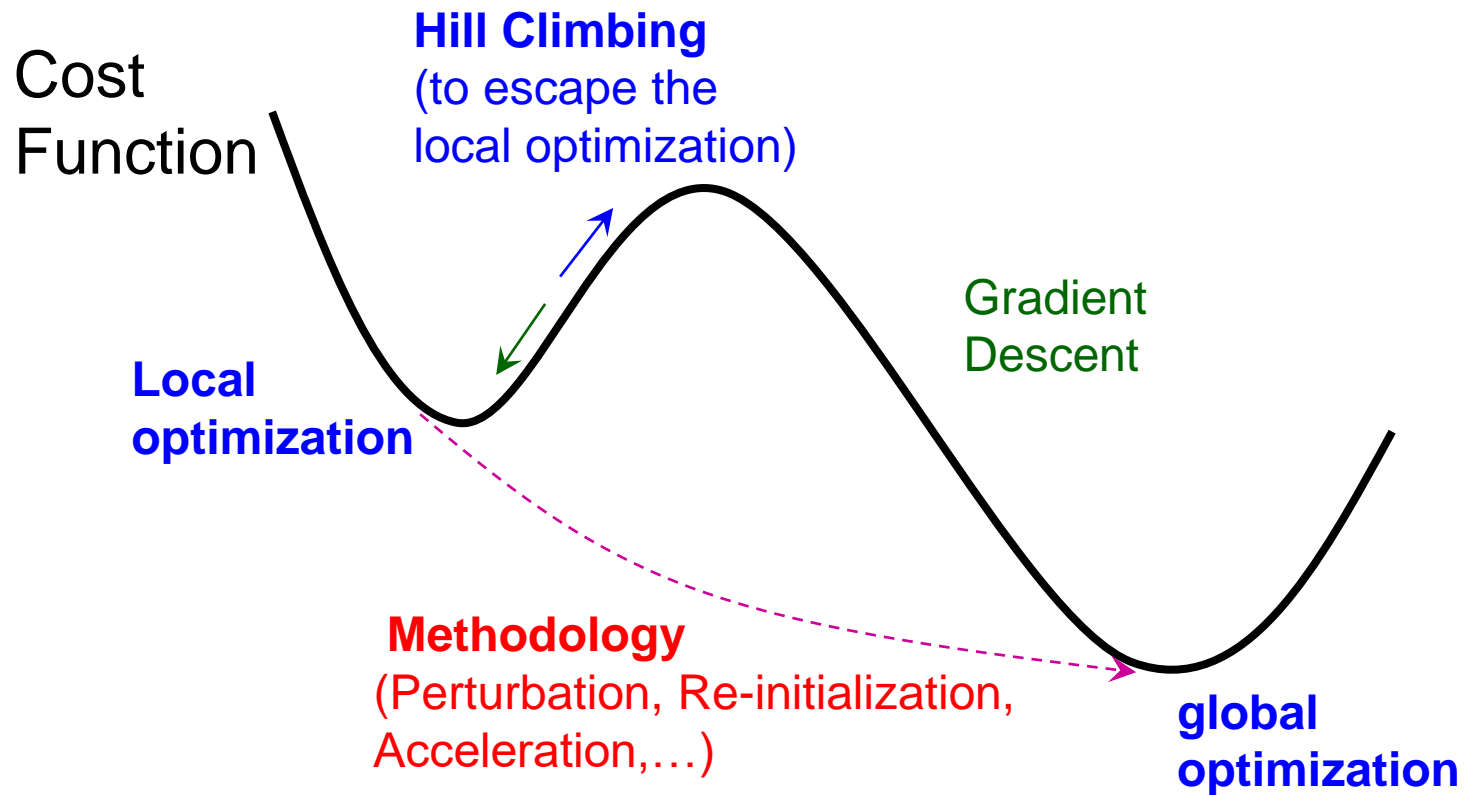



成大研究方向(一)

(Initialization Research: 1988 – 1992)

IEEE 2018
Seminar

Starting Research Topics in NCKU :

- Adaptive Spectrum Estimation (Optimal to Adaptive Methods)
- Adaptive Array Signal Processing (Optimal to Adaptive Methods)
- Neural Networks

Teaching Courses in NCKU :

- Communication Systems
- Digital Signal Processing
- Adaptive Signal Processing (based on Adaptive Spectrum Estimation)
- Neural Networks (Active in 1986)

1. Transferred Ph.D. research;
2. Avoid optimal problems;
3. Create new related research;
4. Research on PC with MATLAB



成大研究方向(二)

(Multimedia Migrated Research:1990 – 2014)

IEEE 2018
Seminar

New Research Topics in NCKU :

- NSC Top-Down HDTV Research Program
- Audio and Speech Coding (Fast and Recursive Methods)
- Image and Video Coding (Fast Algorithms)
- VLSI Design for DCT,

Migration of Research Directions :

- Fast/Adaptive Multimedia Systems
- Open **Digital Video** and **Digital Speech Processing** Courses
- Given up Researches in Adaptive Signal Processing and Neural Networks
- Given up Audio and Speech Related Researches

Ways of Research Migration:

1. Related Migrations
2. Open New Courses,
3. Master Students First,
4. Ph.D. Followed Strategy



成大研究方向(三)

(Industrial Focused Research: 2014 – 2018)

IEEE 2018
Seminar

3D Technology Focused Research:

- Purchased Philip First Naked-eye 3D Display
- Designs of 3D Packing Format
- International Standardization and Patents

Promotion Standards
in MPEG and AVS
Standard Meetings

Smart Living Focused Research :

- Face and Object Recognition
- Advanced Driver Assistance System
- Smart Detection of Car, Bikes, and Pedestrian
- AI and Deep Learning Algorithms

National AI
Campaign Program
and International
Hot Trends



研究最佳化

(Research Optimization)

IEEE 2018
Seminar

Cost Function

(Dynamic Goal/Efforts)

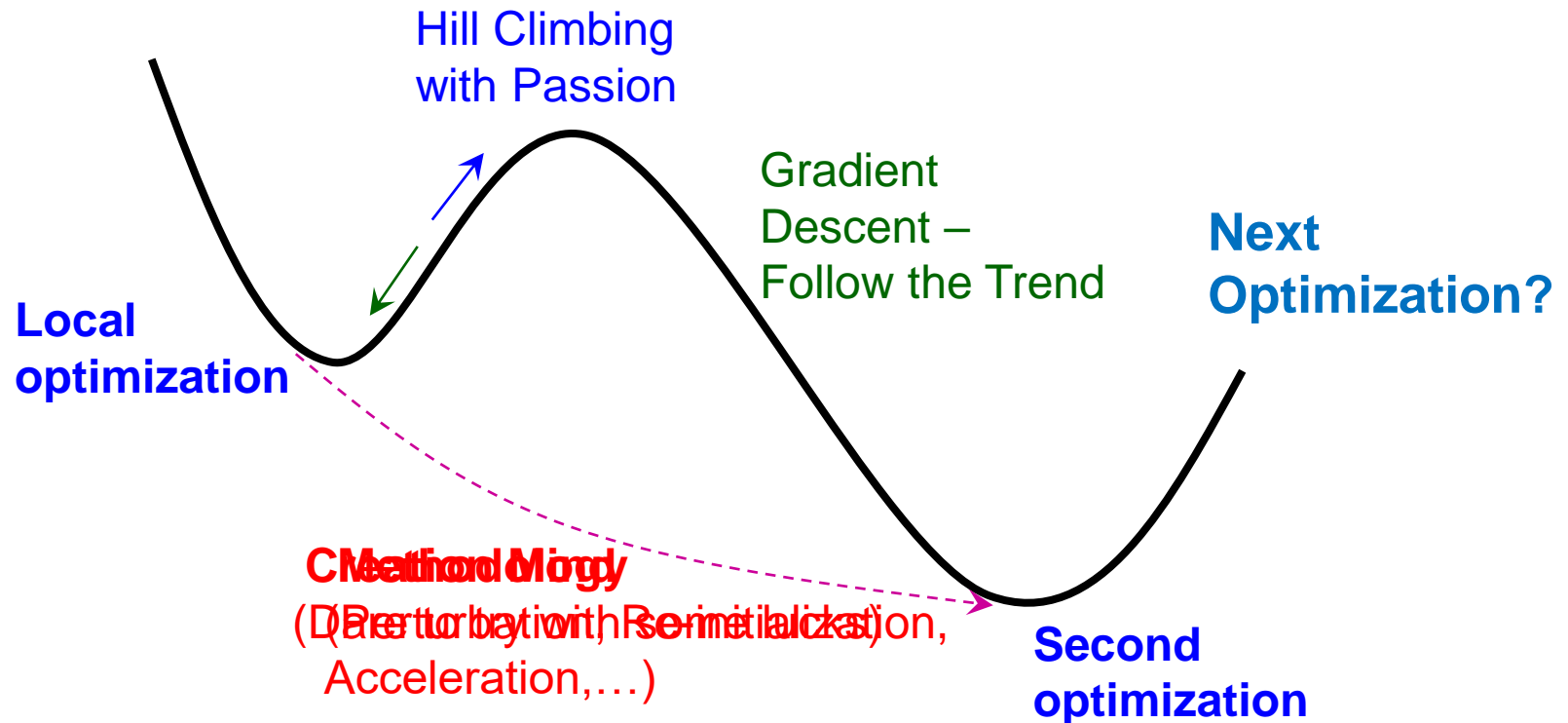



研究成果包裝與提升

(Promoting Research)

IEEE 2018
Seminar

Publishing Top Research Papers:

- Select Research Topics – Learnt from Keynote Speech/Training Course
- Promotion Yourself in Target International Organization
- Make Friends in Conferences and Their Side Meetings

Seeking Nation and International Recognitions :

- Research with Some Good Papers – (most important)
- Search Academic Services: Associate Editor, Conference Chair,
- Show Yourself in Certain Platforms
- Plan Yourself with Good Strategy

Active and
Proactive Ways?



國際學會組織與架構 (IEEE)

IEEE 2018
Seminar

IEEE Organization (Regional Activities)

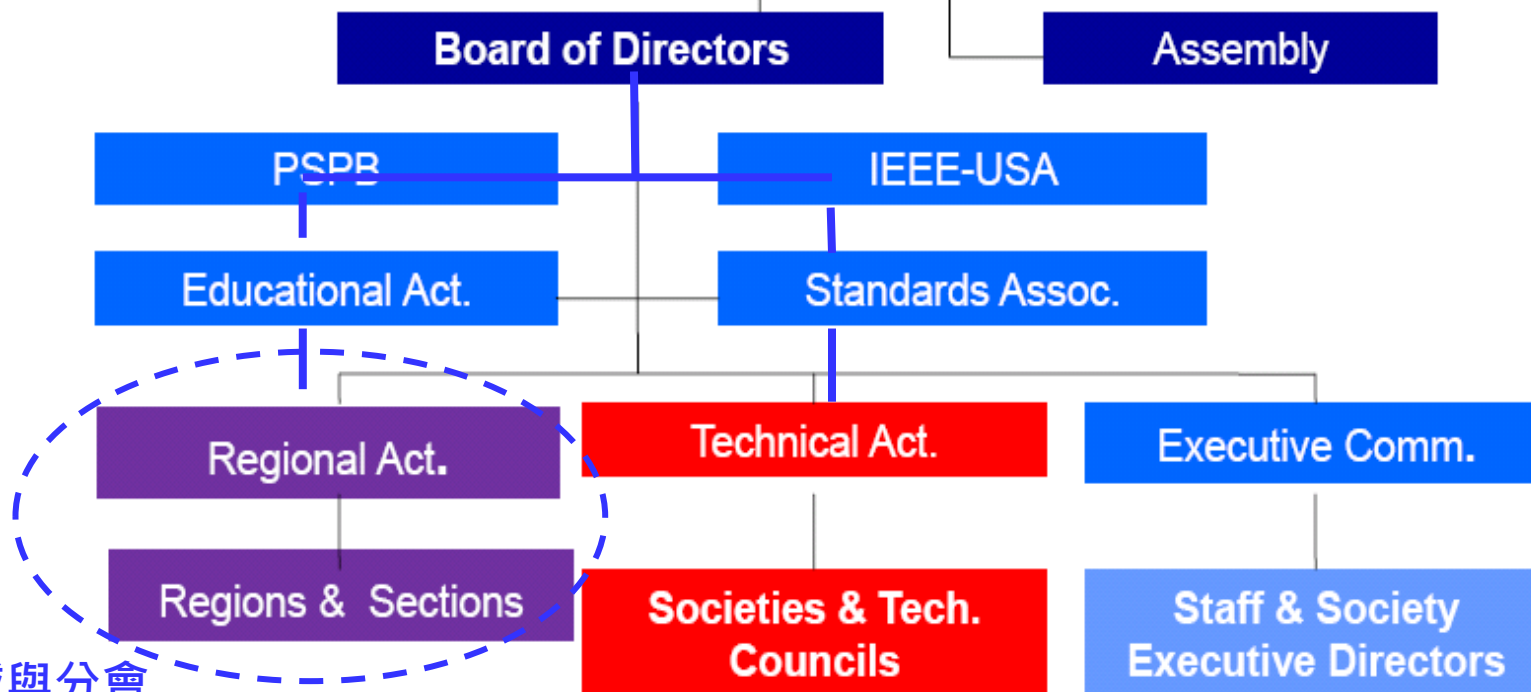

區域與分會



國際學會組織與架構

(地理性區域Geographical組織)

IEEE 2018
Seminar

Region 10: Asia Pacific and Australia

(6 Councils and 56 Sections)

Region 10

Director
Treasure
Committee

Tainan Section

Chair
Vice Chairs
Treasure
Secretary
Committee

Tainan Chapters

Chairs
Vice Chairs
Secretaries
Committee

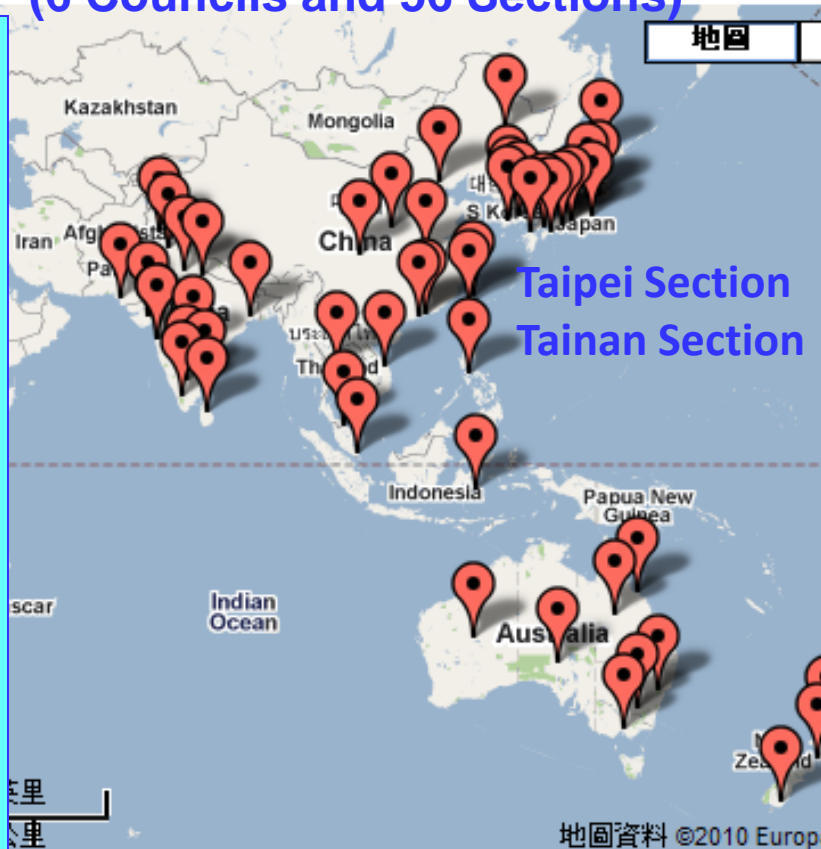

Region 10

Annual Meeting

Director
Treasure
Committee
Section Chairs

Tainan Section Annual Meetings

All IEEE
Members

Tainan Chapters Meetings

All Chapter
Members



國際學會組織與架構

(IEEE Technical Activities)

IEEE 2018
Seminar

IEEE Organization (Technical Activities)

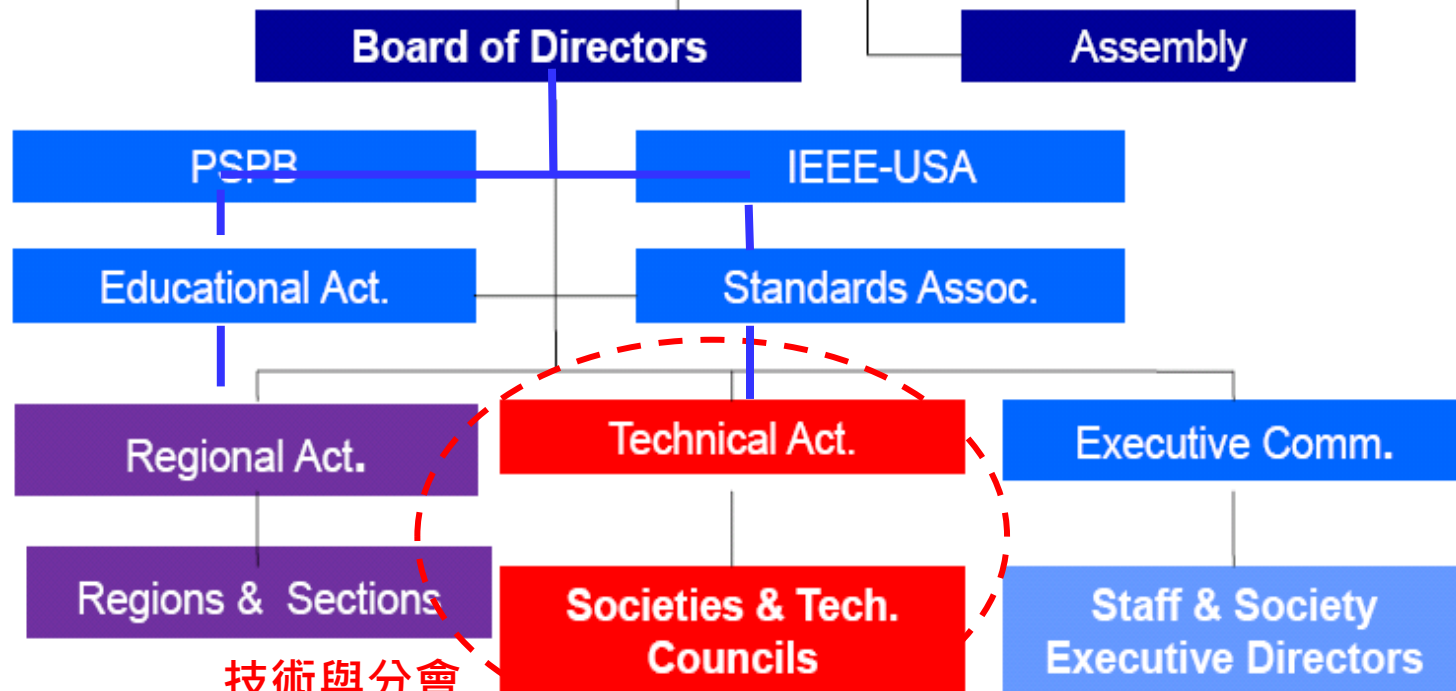

技術與分會



國際學會組織與架構

(技術性學會Divisions)

IEEE 2018
Seminar

IEEE Technical Divisions

- I Circuits and Devices
- II Industrial Applications
- III Communications Technology
- IV Electromagnetics and Radiation
- V Computer
- VI Engineering & Human Environment
- VII Energy and Power Engineering
- VIII Computer
- IX Signals and Applications
- X Systems and Control,



國際學會組織與架構

(技術性學會-Division-I)

IEEE 2018
Seminar

IEEE Technical Division I : Circuits and Devices



IEEE COUNCIL
ON ELECTRONIC
DESIGN AUTOMATION





國際學會組織與架構

(技術性學會之服務 Technical Services)

IEEE 2018
Seminar



**IEEE CIRCUITS AND
SYSTEMS SOCIETY**

Circuits and Systems Society

Society Major Activities (Services):

Publications

Journals, Transactions, Letters

Conferences

Meetings, Symposium, Workshops
Sponsorship, Technical Sponsorship
Proceedings, Abstract, Digests

Chapters

Local member activities
Society direct contact to members

Education, Award, Fellow Evaluation

President, Vice Presidents
Board of Govern, Committee

Editor-in-Chief, Associate Editors,
Reviewers, Authors

Conference Chairs,
Technical Committee
Review Committee Members,
Reviewers, Authors

Chapter Chair
Vice Chair,

Fruits always go to those who,



國際學會組織與架構

(參與服務技術性學會 Society Services)

IEEE 2018
Seminar



IEEE CIRCUITS AND
SYSTEMS SOCIETY

Circuits and Systems Society

Society Major Activities (Services):

Publications

Journals, Transactions, Letters

Conferences

Meetings, Symposium, Workshops
Sponsorship, Technical Sponsorship
Proceedings, Abstract, Digests

Chapters

Local member activities
Society direct contact to members

Education, Award, Fellow Evaluation

Order in Publication Services:

1. Authors
2. Reviewers
3. Associate Editors
4. Editor-in-Chief

Order in Conference Services:

1. Authors
2. Reviewers
3. Committee Members
4. Review Committee Members,
5. Technical Committee Chairs
6. Conference Chairs



國際學會組織與架構

(技術性與區域性Regional Services)

IEEE 2018 Seminar

Chapter: (Region and Society)

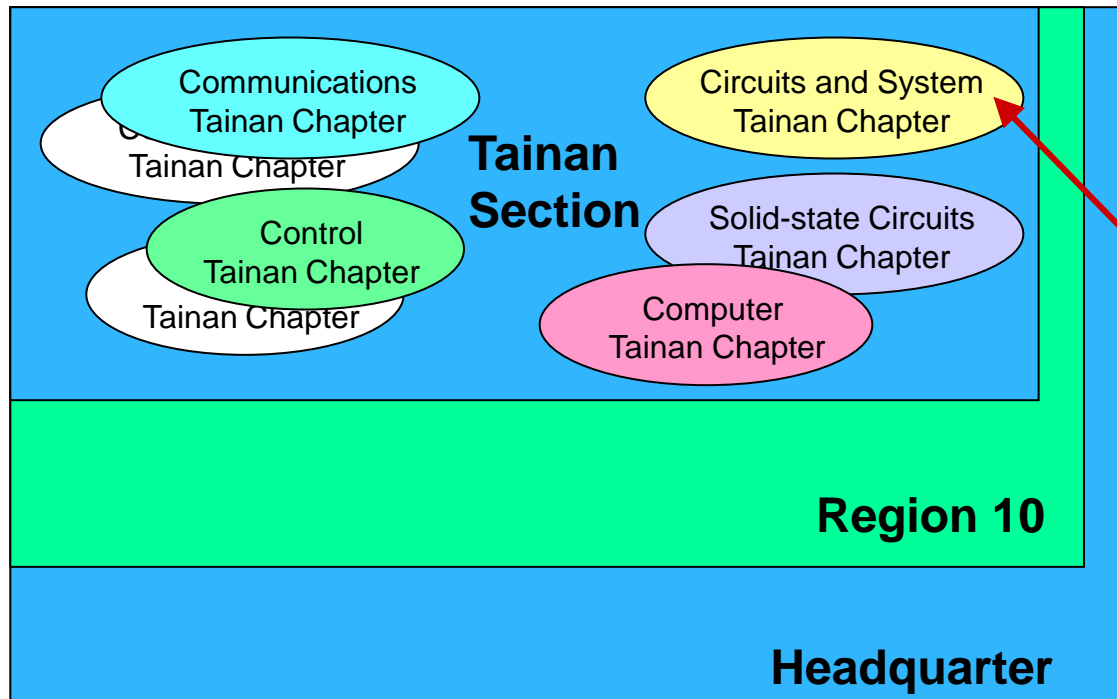

Leaded by Both Academic and Industrial Members



Mostly Led by Academic Members

A good starting point to introduce yourself and initialize services

a kind of recognition of your achievement by the members within your local region



正常國際學會參與

(Passive During 1988 – 2004)

IEEE 2018
Seminar

Join IEEE Signal Processing and Circuits and Systems Societies:

- Research! Research! and Research!
- Pay IEEE Member Fee
- Read and Review IEEE Transaction and Conference Papers
- Submit Paper to IEEE Transactions and Journals
- Submit Papers to IEEE Conferences
 - SPS and CAS Major Conferences (ICASSP, ISCAS)
 - Selected Conference Sites, which I've never been there
 - Submit 4 - 5 papers
- Participate IEEE Conferences
 - Joint tutorial lectures
 - Present papers
 - Join banquet and conference tours
 - Stay in cheaper conference hotels
 - Sit in the conference rooms to listen and learn
 - Discuss all the authors in poster areas

- **Passive!**
- **Self-Content!**
- **No Focused Society!**
- **Technical Oriented!**
- **No Strategy Plan!**



積極參與國際學會

(Active in 2005 –2014)

IEEE 2018
Seminar

Join IEEE Circuits and Systems Society:

- Researches + **Society Services!** ➤ **Active**
- Pay IEEE Member Fee
- Read and Review IEEE Transaction and Conference Papers
- Submit Paper to IEEE Transactions and Journals
- Submit Papers to IEEE Conferences
 - **Must join CAS major conferences (ISCAS)**
 - **Must join CAS multimedia related conferences**
 - Other Conference Site, if I have time
 - Submit 4 - 5 papers
- Participate IEEE Conferences
 - **Join pre- and post-conference committee meeting**
 - **Join editorial broad meeting of journals**
 - **Talk to society leaders**
 - Present papers
 - Discuss the **key authors and society leaders in poster areas**
 - Join banquet (no tour during the conference period)
 - Stay in **Conference Hotel**

➤ **Focused Society**

➤ **Focused Research Area!**

➤ **Service-Oriented!**

➤ **With strategy plans!**



國際學術服務爭取

(Services in Pursuing)

IEEE 2018
Seminar

Services Record in IEEE CAS

- Chair, IEEE Tainan Section, 2010 -2011
- Chair, IEEE CSS, Multimedia Systems & Application TC, 2007-2009
- Committee, IEEE Best Achievement Award Committee, 2009
- IEEE Fellow , 2007
- Associate Editor, IEEE Trans. on CSVT, 2007-2009
- Editorial Board, IET Signal Processing, 2007
- Steering Committee, IEEE Transaction on Multimedia, 2008-2010
- Associate Editor, EURASIP Research Letters in Signal Processing, 2006
- Associate Editor, EURASIP Journal on Advances in Signal Processing, 2004
- Treasure, IEEE Tainan Section, 2003 - 2009
- General Secretary, IEEE ISCAS 2009,
- Secretary, IEEE CSS, Multimedia Systems & Applications TC, 2005-2006
- Member, IEEE CSS, Multimedia Systems & Applications TC, 2004 - Present
- Member, IEEE Visual Signal Processing and Communication TC, 2004 - Present
- Member, IEEE Life Science Systems and Applications TC, 2004 – present
- Run for Vice President (VP) , Conferences , IEEE CSS, 2010 (Failed)
- Run for Board of Govern (BOG), IEEE CSS, 2006 (Failed)

2004



建立國際化推動團隊

(GLPP)

IEEE 2018
Seminar

Group Leadership Promotion Program (GLPP)

■ Proactive Attitudes and Skills:

You have to be proactive and establish close interactions with key leaders. Take good use of email communication:

The power of “CC” --- a Close-Loop Control

■ Subgroup Works:

Team in subgroup bases can share heavy load of interactions and resources to the Society. Besides, proactive team always makes you naturally comfortable!

■ Personal Goal and Diversity Approach:

It is a personal goal to proactive join the Society by various approaches, which could turn your services to visible achievements. The most important thing is to comfortably enjoy as a self-fulfillment.



結論

(Conclusions)

IEEE 2018
Seminar

- 自我設定：成長於學校，成熟於台灣，發光於國際
集中研究與服務之能量於特定主題
- 自我約束：低調於學校，自信於台灣、表現於國際
低調比過火好 (依個人之個性)
- 服務(舉辦研討會、擔任期刊副編、擔任技術委員)為上策
自助人助 比 無事無助 好
- 消極、等待、參與的心態 換成 積極、進取、運用的心態
組織團隊合作比個人單兵作戰好

參與國際組織是一項犧牲享受、享受犧牲的長期工作!!

IEEE 2018 Seminar

Q & A

研討會簡報檔案

可至成功大學圖書館網站 最新消息下載